

# REVISION

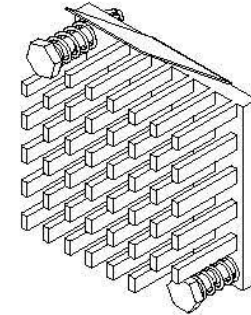
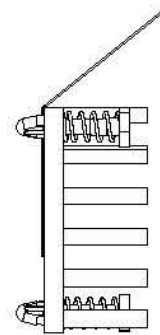
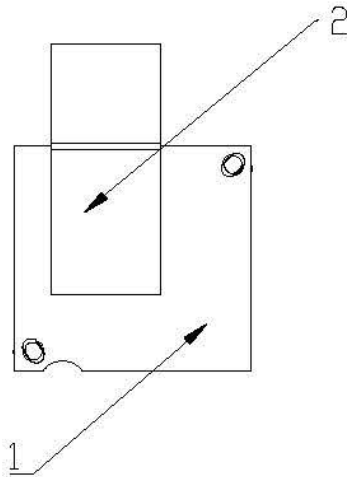
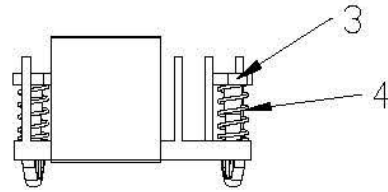

RoHS compliance

no.	ITEM	DESCRIPTION	QTY*	REMARK
	SPRING	W160426702,SST316,PASSIVATE	4	
	PUSHPIN	W160426701,MATERIAL OF PUSHPINNYLON 6/6 ,FLAME RATING V2,COLOR BLACK	4	
	PAD	TP161112304,PTM5200	1	
	HEATSINK	HT161112304,AL6063-T5,CLEAR	1	

未標註之尺寸其公差為: LIMITS UNLESS OTHERWISE NOTED							
** TOL±							
0~6	0.05	0.1	0.1	0.2	0.05	0.1	0.5
6~30	0.1	0.2	0.15	0.25	0.1	0.15	?
30~80	0.15	0.25	0.2	0.3	0.2	0.4	2
80~180	0.15	0.3	0.25	0.45	0.4	0.8	3
180~315	0.2	0.5	0.4	0.6	0.4	1.2	3
315~800	0.3	0.8	0.7	1.1	0.6	1.5	4



**THERMO COOL**

www.thermocoolcorp.com  
408.947.7400  
sales@thermocoolcorp.com

圖號 Drawing No.:

PT16304



UNIT : mm

比例 SCALE:

1:1

日期 DATE:

2016.11.12

版序 VER:

B

確認 APPROVAL:

Laman

覆核 CHECKED:

Frog

製圖者 DRAWN:

陸仁

Thermo Cool Part:TC-3242 Rev D

Customer Part:00329 Rev 01

Project Name:PT16304

Type:SEE BOM

Finish:SEE BOM

Material:SEE BOM

# REVISION

REV.	Description	Date	Engineer
B		2016-09-22	陆仁

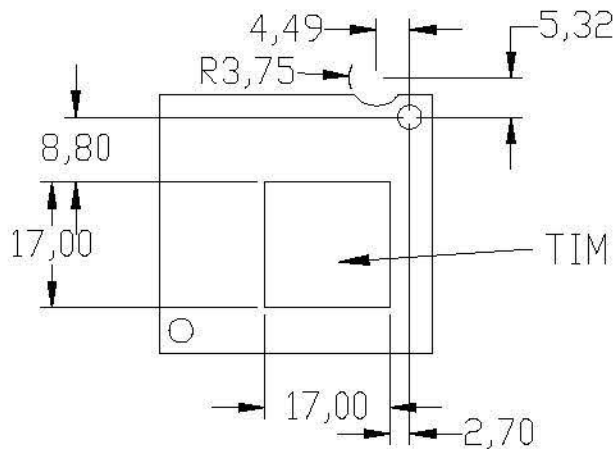
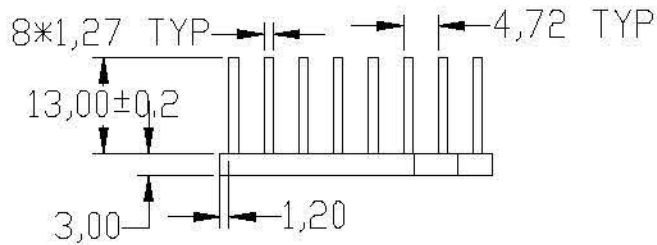
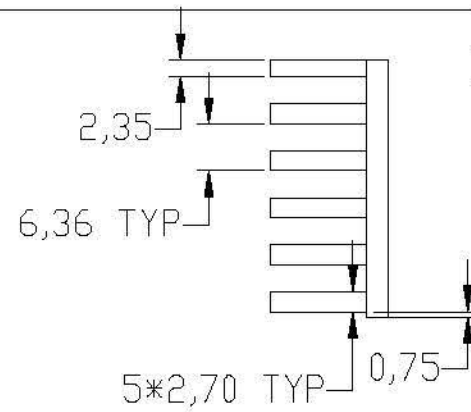
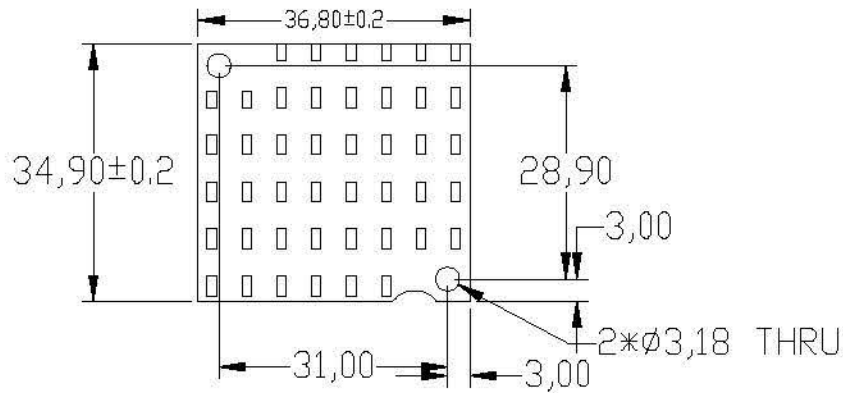

TIM MATERIAL LOCATION

Sign \_\_\_\_\_ Date \_\_\_\_\_

RoHS compliance

LIMITS UNLESS OTHERWISE NOTED: ±0.13

未標註之尺寸其公差為:  
LIMITS UNLESS OTHERWISE NOTED

**	TOL±									
0~6	0.05	0.1	0.1	0.2	0.05	0.1	0.5			
6~30	0.1	0.2	0.15	0.25	0.1	0.15	1			
30~60	0.15	0.25	0.2	0.3	0.2	0.4	2			
60~180	0.2	0.3	0.25	0.45	0.4	0.8	3			
180~315	0.2	0.5	0.4	0.6	0.4	1.2	3			
315~600	0.3	0.8	0.7	1.1	0.6	1.5				



**THERMO COOL**

www.thermoolcorp.com  
408.947.7400  
sales@thermoolcorp.com

圖號 Drawing No.:

HT161112304

版序 VER:

B

製圖者 DRAWN:

陆仁



UNIT : mm

比例 SCALE:

1:1

確認 APPROVAL:

Lamon

日期 DATE:

2016.09.22

覆核 CHECKED:

Frog

Thermo Cool Part: TC-3242 Rev D

Customer Part: 00329 Rev 01

Project Code: PT16304

Type: Heat sink

Finish: Black Anodized per MIL-A-8625, Type 11, Class 2

Material: AL6063-T5

# REVISION

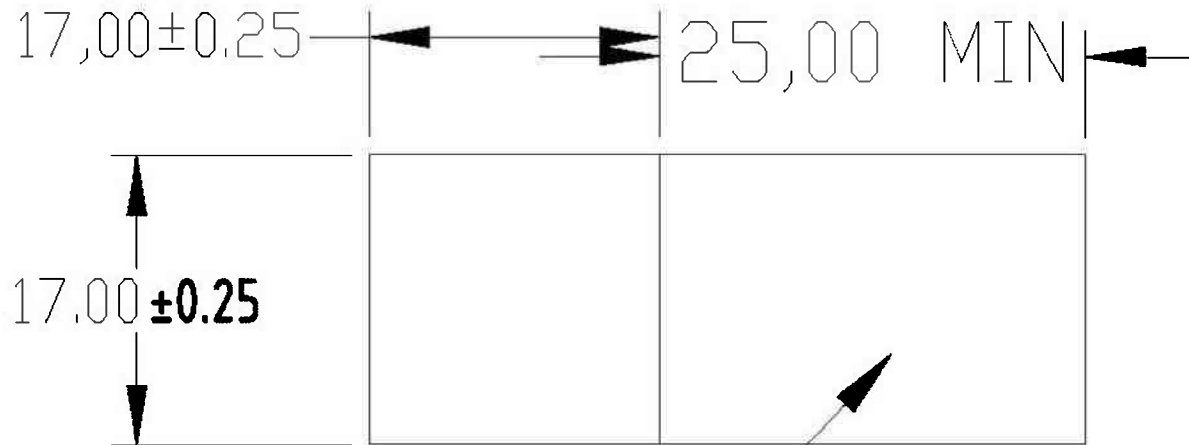

Release Liner

RoHS compliance

LIMITS UNLESS OTHERWISE NOTED:±0.25

未標註之尺寸其公差為:  
LIMITS UNLESS OTHERWISE NOTED

**		TOL±						
0~6	0.05	0.1	0.1	0.2	0.05	0.1	0.5	
6~30	0.1	0.2	0.25	0.25	0.1	0.15	1	
30~80	0.15	0.25	0.2	0.3	0.2	0.4	2	
80~180	0.15	0.3	0.25	0.45	0.4	0.8	3	
180~315	0.3	0.5	0.4	0.6	0.4	1.2	3	
315~800	0.3	0.8	0.7	1.1	0.6	1.5	4	



**THERMO COOL**

www.thermoolcorp.com  
458.947.7400  
sales@thermoolcorp.com

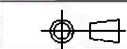

UNIT : mm

比例 SCALE:  
1:1  
確認 APPROVAL:  
Laman

日期 DATE:  
2016.05.13  
覆核 CHECKED:  
Frog

圖號 Drawing No.:

TP161112304

版序 VER:  
B  
製圖者 DRAWN:  
陆仁

Thermo Cool Part:TC-3242 Rev D  
Customer Part: 00329 Rev 01  
Project Name:PT16304  
Type:PAD  
Finish:N/A  
Material:HONEYWELL PTM5200

# REVISION

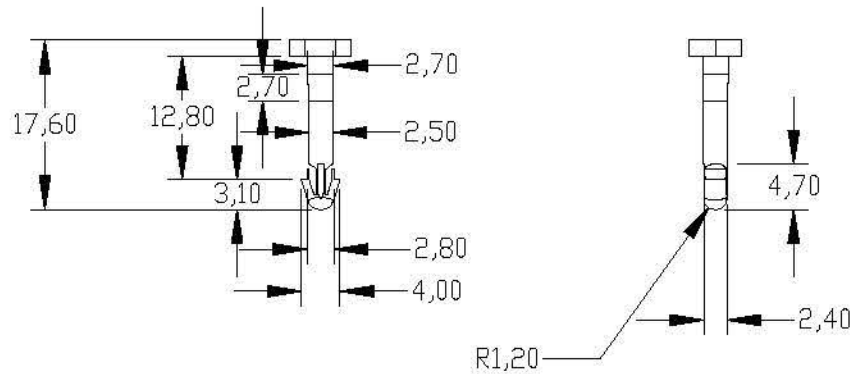
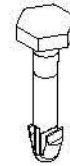
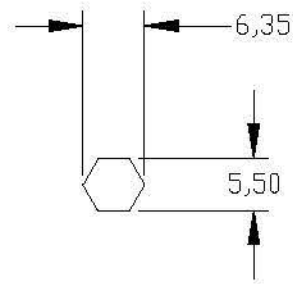

NOTES:

1. MATERIAL OF PUSHPINNYLON 6/6, FLAME RATING V2, COLOR BLACK
2. PUSH PIN CS912B OR EQUIVALENT

RoHS compliance

LIMITS UNLESS OTHERWISE NOTED:±0,25

未標註之尺寸其公差為:  
LIMITS UNLESS OTHERWISE NOTED

**		TOL±						
0~6	0,05	0,1	0,1	0,2	0,05	0,1	0,5	
6~30	0,1	0,2	0,25	0,25	0,1	0,15	1	
30~80	0,15	0,25	0,2	0,3	0,2	0,4	2	
80~180	0,15	0,3	0,25	0,45	0,4	0,8	3	
180~315	0,2	0,5	0,4	0,6	0,4	1,2	3	
315~800	0,3	0,8	0,7	1,1	0,6	1,5		



**THERMO COOL**

www.thermoolcorp.com  
408.947.7408  
sales@thermoolcorp.com

圖號 Drawing No.:

W160426701



UNIT : mm

比例 SCALE:

1:1

日期 DATE:

2016.11.12

版序 VER:

B

確認 APPROVAL:

Laman

覆核 CHECKED:

Frog

製圖者 DRAWN:

陆仁

Thermo Cool Part:TC-3242 Rev D

Customer Part:00329 Rev 01

Project Name:PT16304

Type:SCREW

Finish:SEE NOTES

Material:SEE NOTES

# REVISION

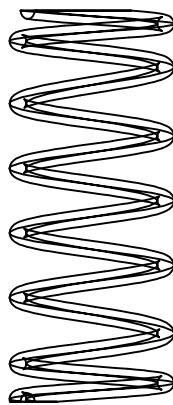
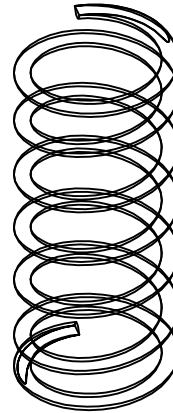
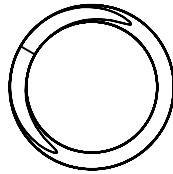

## SPRING DATA

WIRE DIAMETER - 0.49 (0.019 IN)

OUTSIDE DIAMETER - 4.35 MM (0.171 IN)

FREE LENGTH - 11.50±0.38 MM (0.453 IN)

NUMBER OF COILS - 7

ACTIVE COILS - 5

SPRING RATE -0.184 KG/MM (10.3 LBF/IN) +/- 10%

SOLID HEIGHT - 3.50 MM (0.138 IN)

LOAD AT SOLID HEIGHT - 1.13 KGF (2.50 LBF)

END TYPE - CLOSE AND GROUND

RoHS compliance

LIMITS UNLESS OTHERWISE NOTED:±0.25

未標註之尺寸其公差為:  
LIMITS UNLESS OTHERWISE NOTED



**THERMO COOL**

www.thermoolcorp.com  
408.947.7400  
sales@thermoolcorp.com

圖號 Drawing No.:

W160426702



UNIT : mm

比例 SCALE:  
1:1

確認 APPROVAL:  
Laman

日期 DATE:  
2016.04.26

覆核 CHECKED:  
Frog

版序 VER:  
A

製圖者 DRAWN:  
陸仁

Thermo Cool Part:TC-3242 Rev D

Customer Part: 00329 Rev 01

Project Name:PT16304

Type:SPRING

Finish:NICKEL

Material:MUSIC WIRE(ASTM A228)